



FLC 60 DC



FLK 60 DC

USE AND MAINTENANCE MANUAL 533007 GB Rev.0



INDEX

Safety Information _____	pag. 2
Declaration of Conformity _____	pag. 3
Technical Specifications _____	pag. 3
Installation _____	pag. 4
Use _____	pag. 6
Maintenance _____	pag. 6
Troubleshooting _____	pag. 7
Parts _____	pag. 7
Warranty _____	pag. 7

SAFETY INFORMATION

The following safety alert symbols are used in this manual. Obey all safety messages that follow this symbol to avoid possible injury or death.



DANGER!

indicates an imminently hazardous situation which will result in death or serious injury if not avoided.



WARNING!

indicates a potentially hazardous situation which will result in death or serious injury if not avoided.

It is responsibility of the person that use the pump to:

-) Know and follow applicable national and local safety rules pertaining to installing and operating electrical equipment for use with petroleum fluids.
-) Know and follow adequate safety precautions when handling petroleum fluids.
-) Insure that all operators -must be adults only, children cannot use the pump- have access to adequate instructions concerning safe operating and maintenance procedures.



DANGER!

This pump is designed for automotive Diesel fuel only. The pump is not suitable for food substances transferring. The motor of the pump is not explosion proof, do NOT USE the pump in ambient with flammable vapours. Do NOT USE the pump whit gasoline, petrol or other flammable liquids with flash points less than 55°C (131°F), DO NOT use this pump to transfer Diesel fuel when ambient temperature exceeds the Diesel flash point temperature 55°C (131°F). DO NOT operate the pump in the presence of any source of ignition including running or hot engines, lighted cigarettes or gas or electric heaters. For safe operations, the diesel fuel transfer system must be properly grounded, this means a continuous metal to metal contact between components, supply tanks, pump, hose, metal nozzle and receiving tank. Failure to follow the above mentioned instructions may result in death or serious injury from fire or explosion.



WARNING!

This manual is integrating part of the pump. Before starting, in the way to get the best results and the maximum performance from the pump, please read carefully these operating instructions and store the manual in a safe place. Don't leave the running pump unwatched, when the pump is not in use, store it in a safe place out of reach of children. When the pump is not in use and before of any maintenance, installation or inspection, disconnect the pump from the power supply. To disconnect the plug do not pull the cable, but remove directly the plug/clamps; don't touch plug/clamps/switches with wet hands. It's forbidden modify any part of the pump. Prevent any injury observing the basic safety rules. Use the pump for Diesel transferring only: a misuse of the pump can results dangerous for people, wares and/or animals. During the transferring operation, pay attention to avoid any splash of Diesel; avoid prolonged contact of your body with Diesel fuel. It's recommendet the use of protective glasses, gloves and aprons in case of splashing or spiling.

Before of use, chek always that the pump is in order: if any problem is found don't use the pump and solve the problem and, if necessary, contact the service. Never point the Diesel jet at electrical equipment, cables, open flames, hot object, persons, animals, wares or other place different from the receiving tank.

DECLARATION OF CONFORMITY

We:

FLUID s.r.l.
via G. Fucà, 119
41100 Modena - ITALIA

herewith declare that the construction of the pumps

FLC 60 DC- FLK 60 DC

complies with the following relevant regulations:

98/37 CEE - 73/23 CEE - 89/336 CEE

complies with the following relevant standards:

EN 292/1

EN 6100-6-1

EN 60335-1

EN 292/2

EN 6100-6-3

EN 294

EN 60204-1

complies with the following national standards:

DPR 547/55

Modena, lì 15/09/2007

Legal Rappresentative
 Giovanni Bedoni

TECHNICAL SPECIFICATIONS

Self-priming rotary vane pump, equipped with by-pass valve and filter integreted in the pump body, driven by a brush DC low tension motor, in protection class IP 55, designed for the transfer of Diesel fuel.

The pump is designed for an intermittent use, with a working cycle of 40 minutes (40 min ON / 40 min OFF)

FLC 60 DC: Electric pump 12/24V with shell in painted steel, ON/OFF switch, cable with fuse and clamps suitable for a quick connection to the battery.

FLK 60 DC: kit including FLC 60 DC, suction hose 1", antistatic delivery hose 3/4" and nozz-
 le with swivle connection.

Type	Tension V (+/-5%)	Power max W	Current nom. A	Current max. A (by-pass)	Fuse	Port	Weight Kg
FLC 60-12 DC	12	336	19	25	•	1"	5,2
FLC 60-24 DC	24	432	11	18	•	1"	5,2
FLK 60-12 DC	12	336	19	25	•	1"	9,8
FLK 60-24 DC	24	432	11	18	•	1"	9,8

Noise level

Under normal working conditions, the noise emission pression do not exceed the value of 70 dB at the distance of 1 meter from pump.

Diesel fuel flow

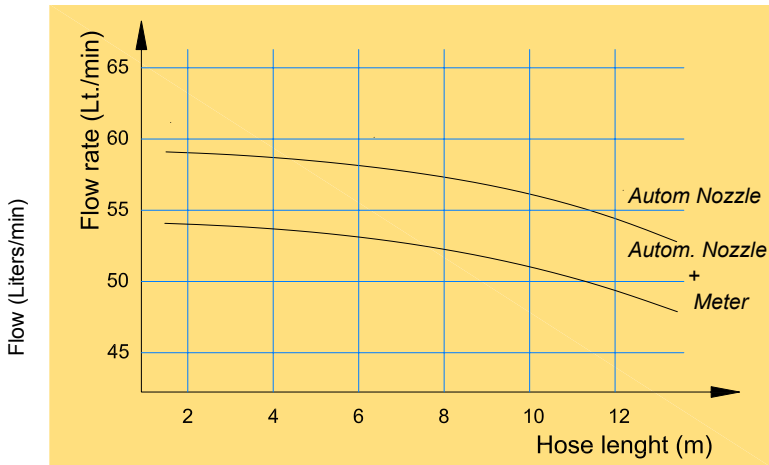

Delivery hose length (meters)

To get the maximum pump flow rate it's necessary:

-) Minimize length of suction and discharge lines;
-) Avoid, if possible, elbow and throttling along the line;
-) Use tubing with diameter equal or greater than 3/4";
-) Keep clean the strainer regularly;
-) Use extension cable only if necessary (max 5 mt. length, minimum section 2x4 mmq).

Product identification

Serial Number

Product Description

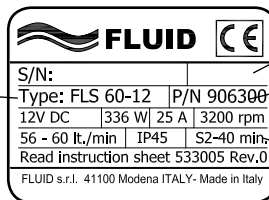

Date of Production

Product Code

Technical Data

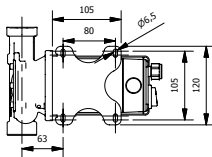

Dimensions

FLC 60 DC

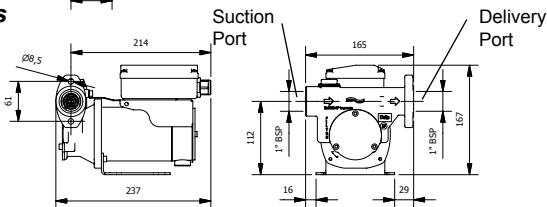

INSTALLATION



DANGER!

If the application is for gasoline, petrol or fluids that require an explosion-proof product, DO NOT INSTALL THIS ELECTRIC PUMP.

Preliminary operations:

-) Check that the product has not suffered any damage during transport or storage, in case of damages or missing parts, please contact immediately the dealer.

-) Remove the protection plugs on inlet and outlet of the pump;
-) Fix the pump using screws of adequate diameter for the fixing holes provided in the bracket of the pump.

Tubing connection

FLK 60 DC: Connect the suction hose (cyan colour) on suction port and the delivery hose (black colour) on delivery port (see picture “Dimensions” pag. 4)

FLC 60 DC: Before connection make sure that the tubing, the inlet - outlet of the pump and the suction tank are not clogged and free of dirt, rust, etc. that could damage the pump and/or clog the retainer. The threaded connections must be 1” BSP type (do not use conical threaded joints that could damage the threaded pump bores), the pipes connections must be leakage-proof, to avoid air or fuel leakage and pump trouble.

When the hoses are not supplied, it is consiled minimize the lenght of both suction and discharge hoses, use hoses with adequate characteristics for diesel fuel, antistatic, with diameter equal or greater than ¾” and working pressure equal or grater than 10 bar, in addition the suction hose shall be suitable for functioning under suction pressure.

Connect the pump, observing the right fuel flow, like indicated by the arrows on the pump body.

 **WARNING!** The use of tubing unsuitable for use with Diesel fuel can damage the pump, injury persons and produce pollution, because of diesel fuel splashing/spilling.

 **WARNING!** The discharge hose and the accessories (nozzle, meter, etc.) must be grounded (to dissipate the electrostatic currents), alternatively the hoses must be of antistatic type. It is installer responsibility to use tubing with adequate characteristics.

Electrical connections

 **WARNING!** It’s responsibility of the installer to perform the electrical connections with respect for the applicable local or national regulations.

Check that the suppling electrical specifications correspond to those shown on the plate; failure in the electrical specifications respect could damage the electrical pump.

Check the fuse efficiency on the supply cable.

 **WARNING!** Preserve the supply cable from oil, high temperatures and cutting edges. Inspect always the supply cable against damages: in case of damage replace immediatly the supply cable with an original one. Avoid that cables, electrical receptacle, clamps and switches have contact with water or flammable fluids and avoid high moisture ambient for the pump. If necessary, use extension cable 5 meters lenght with minimum section 2x4 mmq, unwinding completely the extension cable.

All metal parts must be always grounded.

Before of electrical connection of the pump, be sure that the swicht is in OFF position, than wire the 2 clamps: red clamp at positive pole (+) and black clamp at negative pole (-) of the battery.

USE

 **DANGER!** To prevent injury, observe precautions against electrical shock, fire or explosion when dispensing fuel. Do not operate switch with wet hands. Do not operate the pump in the presence of any source of ignition including running or hot engines, lighted cigarettes or gas or electric heater.

Start the diesel fuel dispensing turning ON the switch on the pump and opening the delivery valve (the lever of the nozzle, if present) solidly grasping the end of the hose; **at the end of the diesel fuel dispensing turn OFF the switch of the pump and disconnect the main power supply.**

 **WARNING!** Operate the pump in ambient with temperature between -15°C and +40°C. Serious or fatal shock can result from operating electrical equipment in dump or wet locations.

 **WARNING!** Avoid prolonged contact with petroleum fuels. Use protective goggles, gloves and aprons in case of splashing or spills. Change saturated clothing and wash skin promptly with soap and water.

This pump is designed for the transfer of diesel fuel with flash point at or above 55 °C (131°F). DO NOT USE this pump for other types of fluid. Use of this pump with other types of fluid may damage components and will void the warranty. The pump is not suitable with alimentary or food fluids.

Operation without fluid

 **WARNING!** DO NOT LEAVE the pump running without fuel. Dry running (even for few minutes only) can damage the pump.

Operating in by-pass

Pump is equipped with an automatic by-pass valve. Pump will go into by-pass when the discharge line is close. To prolong the life of the pump, minimize time spent in by-pass.

 **DANGER!** Operation with the discharge line closed -by-pass mode- is allowed for maximum 3 minutes only. Longer pump running in by-pass mode produce abnormal diesel fuel temperature raising, with all the fire or explosion risks connected.

MAINTENANCE

 **WARNING!** Observe precaution against electrical shock when servicing the pump! Always disconnect power before attempting any service. Never apply electrical power to the pump when any of the cover plates are removed. The pump is designed for minimal maintenance, it is recommended observe the following indications:

Daily:

Keep the pump exterior clean to help identify leaks, check the connection/joints sealing and repair immediately any leakage, if necessary. Check the electrical cable conditions: if damages/cuts or other defects are recognized, it is necessary replace the cable with an original one, this operation must be performed by an expert technician, accordingly with local regulations.

Check the conditions of suction and discharge hoses: if fissures, cuts, bulges or other damages are recognized, it is necessary replace the hose with an original one.

Weekly or every 5 hours of work:

Inspect and/or clean the strainer integrated in the body pump: a clogged retainer reduce the fuel flow delivery and the pump lifetime; to disassemble the retainer unscrew the plug on the pump body (2, pag. 7) and remove the strainer from its seat, clean by air-blast spray, then reassemble the strainer and the plug.

Every 2 years it's recommended replace the discharge hose.

Transport

Switch off the pump, disconnect the electrical wiring, disconnect the lines and flush the pump. Package properly the pump unit and be care to avoid shocks during the transportation.

Disposing of contaminated materials

Don't disperse contaminated parts into the environment. Refer to local regulations for proper disposal of the product.

TROUBLESHOOTING

Troubles	Possible Cause	Corrective Action
Motor does not run	No electrical power to pump	Check electrical connections, extension cable and fuse. Check for possible locking of rotating shaft
Motor runs slowly and low fuel flow	Low voltage in the electric line	Bring the voltage in the correct limits Using extension cable, cable sections shall be at least 2x4 mmq, 5mt. long max.
Motor runs, but no fuel delivery	Tank level low Clogged suction line Air leak in system	Add fuel to tank Clean suction line Check all joints

PARTS

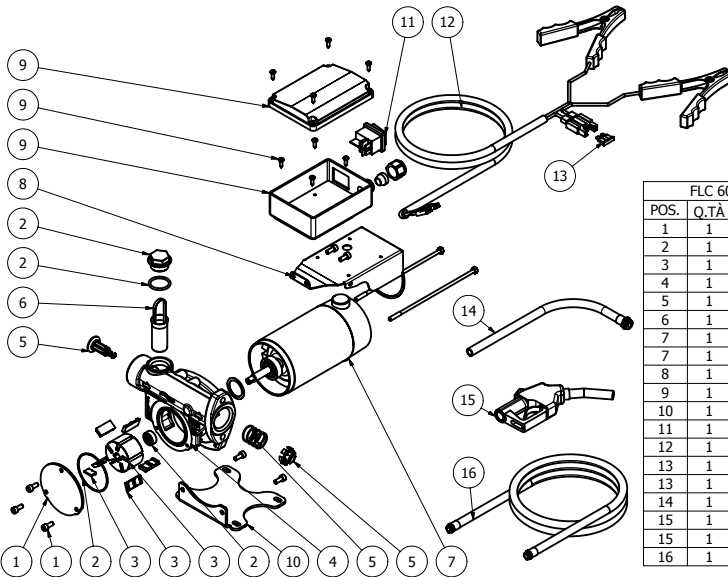

FLC 60 - FLK 60 12V-24V DC PARTS			
POS.	Q.TÀ	DESCRIZIONE	CODICE
1	1	Cover + screws kit	695005
2	1	Gaskets Kit	695001
3	1	Rotor + vanes kit	695002
4	1	Pump body 60 lt.	210002
5	1	DC by-pass valve kit	695016
6	1	Strainer	217001
7	1	24 Vcc motor	460102
7	1	12 Vcc motor	460101
8	1	FLC 60 DC cover kit	695017
9	1	Electrical box kit	695006
10	1	FLC 60 DC bracket kit	695018
11	1	ON/OFF Switch	425001
12	1	Cord 2x4 4mt + clamps	400003
13	1	25A fuse (12 Vcc motor)	450001
13	1	15A fuse (24 Vcc motor)	450002
14	1	Suction hose	990201
15	1	Autom. nozzle 60 Lt/min	320601
15	1	Alumin. nozzle 60 Lt/min	321601
16	1	Delivery hose 1"-4 mt	990104

WARRANTY

The product is guaranteed in accordance with statutory/country-specific regulations, only when it is used for the designed purpose. The warranty period shall begin on the date of purchase with an original sales receipt. The warranty is limited to demonstrable defects that can be attributed to workmanship and/or material; the buyer will pay for any transport costs and will bear any transporting risks responsibility. Failure/defects resulting from normal wear, incorrect and/or improper use, erroneous connections of the device, manomissions or modifications (without our written authorization) are not covered by the warranty. The manufacturer exclude any additional liability, in particular for subsequent ware or persons damages arising from the use of the product.



Timbro Rivenditore - Dealer's stamp

 **FLUID** s.r.l.

Fuel Transfer Equipments

via G. Fucà, 119 ZI Torrazzi Sud

41100 Modena (MO) Italy

Tel. +39 059 250307

Fax +39 059 250307

e-mail: info@fluiditalia.it

www.fluiditalia.it

Pictures and descriptions are FLUID srl properties. Technical datas and characteristics indicated are intended not binding and FLUID srl could change them without any advanced notice.